

Art of the Master's Touch

JDH DESIGN

Art of the Master's Touch



NEW HOMES @ 519-A & B
WEAKLEY AVE., NASHVILLE, TN 37207

NEW HOMES @ 521-A & B
WEAKLEY AVE., NASHVILLE, TN 37207

Art of the Master's Touch

JDH DESIGN

Art of the Master's Touch

GENERAL NOTES

1. THE GENERAL CONTRACTOR SHALL VERIFY ALL DIMENSIONS AND SITE CONDITIONS BEFORE COMMENCING WITH WORK. THE DESIGNER MUST BE NOTIFIED OF ANY DISCREPANCIES BEFORE PROCEEDING WITH THE WORK.
2. DO NOT SCALE DRAWINGS. IF DIMENSIONS ARE IN QUESTION, OBTAIN CLARIFICATION FROM THE DESIGNER BEFORE CONTINUING WITH THE WORK.
3. DIMENSIONS ARE WITTENED TO FACE OF MASONRY OR TO FACE OF STUD UNLESS OTHERWISE NOTED.
4. ALL WORK PERFORMED UNDER THIS CONTRACT SHALL MEET ALL STATE BUILDING CODES, THE NATIONAL ELECTRIC CODE, AND ORDINANCES OF THE LOCAL AUTHORITY HAVING JURISDICTION.
5. THE DESIGNER SHALL BE NOTIFIED BEFORE PROCEEDING WITH WORK IF A CONFLICT IS DISCOVERED WITHIN THE CONSTRUCTION DOCUMENTS.
6. THERE SHALL BE NO BUILDING MATERIALS CONTAINING ASBESTOS OR OTHER HAZARDOUS MATERIALS INSTALLED ON THIS PROJECT.
7. ALL MATERIALS AND EQUIPMENT PROVIDED SHALL BE INSTALLED AS PER MANUFACTURER'S RECOMMENDATIONS AND AS PER CODE REQUIREMENTS.
8. ITEMS REQUIRING FINISH SELECTIONS NOT APPEARING IN THE DOCUMENTS SHALL BE SELECTED BY THE OWNER FROM SHOP DRAWINGS, SUBMITTALS, AND/OR SAMPLES AS REQUIRED.
9. THE DESIGN, ADEQUACY, AND SAFETY OF ERECTION BRACING, SHORING, TEMPORARY SUPPORTS, ETC., IS THE SOLE RESPONSIBILITY OF THE GENERAL CONTRACTOR.
10. FILL SOLID ALL MASONRY VOIDS WHERE ANCHORS OCCUR.
11. COORDINATE LOCATIONS AND/OR ELEVATIONS OF FLOOR DRAINS, REGISTER, GRILLES, LOUVERS, PANELS, ETC., WITH MECHANICAL AND ELECTRICAL CONTRACTORS.
12. SIZE AND LOCATION OF ALL FLOOR OPENINGS TO BE VERIFIED WITH THE TRADE AFFECTED BEFORE PROCEEDING WITH THE WORK.
13. BOLTING OF WOOD TO STRUCTURAL MEMBERS OR MASONRY SHALL BE WITH A MINIMUM OF 1/2" BOLTS 48" ON CENTER UNLESS OTHERWISE SHOWN OTHERWISE.
14. PROVIDE LANTERNS OVER ALL OPENINGS INCLUDING THOSE REQUIRED FOR OUTDOOR PIPES, LOUVERS, GRILLES, DAMPERS, ETC.
15. PROVIDE CONCRETE PADS FOR ALL NEW MECHANICAL AND ELECTRICAL EQUIPMENT.
16. PROVIDE DOUBLE STUDS AND BLOCKING WHERE REQUIRED TO SUPPORT EQUIPMENT AND/OR MISCELLANEOUS ITEMS, I.E., PIPE, CASEWORK, MILLWORK, ETC.
17. SLOPE ALL GRADES, WALKS AND CONCRETE PADS AWAY FROM BUILDING AT LEAST 1/8" PER FOOT.
18. PROVIDE CONCRETE SPLASH BLOCKS AT ALL DOWNSPOUT LOCATIONS.
19. PROVIDE 6 MIL VAPOR BARRIER UNDER ALL INTERIOR CONCRETE SLAB ON GRADE CONDITIONS.
20. THE "GENERAL CONDITIONS OF THE CONTRACTOR FOR CONSTRUCTION" A.I.A. DOCUMENT A201 IS HEREBY MADE A PART OF THIS PROJECT THE SAME AS IF FOUND HEREIN. THESE CONDITIONS APPLY TO ALL SUB-CONTRACTORS AS WELL AS TO THE GENERAL CONTRACTOR.
21. CONTRACTOR SHALL MAINTAIN THE JOB CLEAR OF TRASH AND DEBRIS. ALL WASTE MATERIAL SHALL BE REMOVED FROM SITE PRIOR TO SUBSTANTIAL COMPLETION AND PRIOR TO FINAL ACCEPTANCE.
22. CONTRACTOR SHALL PRESENT THE BUILDING TO THE OWNER FOR ACCEPTANCE, CLEAN AND READY FOR OCCUPANCY. ALL GLASS SHALL BE CLEANED AND POLISHED, FLOORS SWEEP BROOM CLEAN, FIXTURES WASHED WITH ALL LABELS REMOVED AND THE EXTERIOR TO BE RAZED FREE OF TRASH.
23. CONTRACTOR SHALL VISIT THE SITE AND BECOME FAMILIAR WITH ALL CONDITIONS PRIOR TO COMMENCING CONSTRUCTION. CONTRACTOR SHALL VERIFY ALL DIMENSIONS AND CONDITIONS SHOWN IN THESE DRAWINGS WITH THOSE AT THE SITE. ANY VARIATION WHICH REQUIRES PHYSICAL CHANGE SHALL BE BROUGHT TO THE ATTENTION OF THE ARCHITECT.



NOTICE: THIS RENDERING SHOWS DESIGN INTENT ONLY. ALL CONSTRUCTION PLANS SHOWN HEREIN MUST BE REVIEWED BY A LOCAL DESIGNER OR ENGINEER FOR COMPLIANCE WITH ALL LOCAL CODES AND ZONING REQUIREMENTS AS WELL AS STRUCTURAL AND LOAD REQUIREMENTS. PLUMBING AND MECHANICAL CONDITIONS AND REQUIREMENTS VARY GREATLY FOR EACH REGION. THEREFORE ALL SUCH DRAWINGS MUST BE PROVIDED LOCALLY. ALL PLANS MUST BE REVIEWED IN DETAIL FOR DIMENSIONS AND NOTATION. ANY DISCREPANCIES OR ERRORS SHOULD BE REPORTED TO JDH DESIGN IMMEDIATELY SO THAT ADJUSTMENTS CAN BE MADE. JDH DESIGN MAKES NO WARRANTIES OR GUARANTEES FOR THE CONSTRUCTION OF THIS HOME.

DRAWING INDEX

- COVER SHEET
- GENERAL NOTES AND SPECIFICATIONS
- A-1.0 SITE PLAN LAYOUT
- A-1.1 FRONT AND REAR ELEVATION
- A-1.2 RIGHT ELEVATION
- A-1.3 LEFT ELEVATION
- A-1.4 FOUNDATION PLAN
- A-1.5 FIRST FLOOR PLAN
- A-1.6 SECOND FLOOR PLAN
- A-1.7 THIRD FLOOR PLAN
- A-1.8 ROOF PLAN
- A-1.9 SECTION & DETAILS

OWNER

A NEW TOWNHOMES FOR:
MARGUERITA JACKSON
 519-A & B WEAKLEY AVENUE
 AND
 521-A & B WEAKLEY AVENUE
 NASHVILLE, TN 37207

NOTICE: This set of drawings for a custom home is the copyrighted property of JDH DESIGN. This single copy is licensed pursuant to the terms and conditions of the design agreement and no right to reproduce or copy any portion of the plans.

These drawings are not to be reproduced by anyone or any method, including blueprinting, xeroxing, photography, tracing, re-drawing, or other means. They may not be used by anyone for resale, construction, sales brochures, advertising, or any other purpose, without written consent of JDH DESIGN.

They may not knowingly be furnished to others for such purposes. They have been prepared by JDH DESIGN as an independent contractor and not as an employee of owner. All original tracing prepared by JDH DESIGN will remain in the office.

JDH DESIGN, 2013

TYPICAL ARCHITECTURAL GRAPHICS SYMBOLS

GRAPHIC REFERENCES		MATERIAL DESIGNATIONS		
	SECTIONS SECTION LETTER SHEET DRAWN ON			
	DETAIL DETAIL NUMBER SHEET DRAWN ON			
	EXTERIOR BUILDING ELEVATION ELEVATION LETTER SHEET DRAWN ON			
	COLUMN GRID			
	WOOD TYPE			
	ROOM NUMBER			
	DOOR NUMBER			
	EQUIPMENT NUMBER			
	REVISION LETTER			
	WORK POINT			
	PROJECT NORTH			
	SOUND BATT INSULATION (SEE PLAN FOR LOCATION)			
	PROPERTY LINE			
	25' NEW CONTOUR			
	30' EXISTING CONTOUR			
	SPOT ELEVATION			

TOWNHOMES @ 519-A & B
 TOWNHOMES @ 521-A & B

GENERAL NOTES AND SPECIFICATIONS

IMPORTANT NOTE: VERIFY GENERAL NOTES & DESIGN GUIDELINES HEREIN, COMPLY WITH CODE REQUIREMENTS OF PROJECT LOCATION. FOLLOW PREVAILING ADOPTED CODES IN LIEU OF GUIDELINES WHERE REQUIRED BY JURISDICTIONAL AUTHORITIES.

GOVERNING CODES:

CODE REVIEW STANDARDS ARE AS FOLLOWS:
1. INTERNATIONAL CODE
2. SOUTHERN BUILDING CODES AND AMENDMENTS
3. MECHANICAL & GAS CODE
4. PLUMBING CODE

GENERAL NOTES:

1. CONNECT WATER, GAS, ELECTRIC LINE TO EXISTING UTILITIES IN ACCORDANCE WITH ADOPTED CODES.
2. VERIFY WITH OWNER ALL MATERIAL SELECTIONS PRIOR TO PURCHASE AND INSTALLATION.
3. ALL CONTRACTORS AND SUB-CONTRACTORS PERFORMING WORK ON THIS PROJECT TO HAVE CURRENT LICENSE FOR SAID WORK, CARRY WORKMAN'S COMP, INSURANCE, AND PROVIDE OTHER INSURANCE, AND PROTECTIONS REQUIRED BY THE OWNER.
4. ALL CONTRACTORS, SUB-CONTRACTORS, OR SUPPLIERS OF MATERIALS OR WORK ON THIS PROJECT RESPONSIBLE FOR REMOVAL AND CLEAN UP OF DEBRIS RESULTING FROM WORK PERFORMED THEREIN.

SOIL:

1. ALLOWABLE SOIL BEARING PRESSURE - 2500 P.S.F. (ASSUMED) MINIMUM
FOOTING DEPTH - EXCAVATE TO UNDISTURBED SOIL DEPTH INSPECTED AND APPROVED BY P.E.
2. PROVIDE TREATMENT COMPLETE WITH WARRANTY TO OWNER.

CONCRETE & FOUNDATIONS:

1. FOOTINGS - 3000 P.S.I. @ 28 DAYS
2. FLOOR SLABS - 2500 P.S.I. @ 28 DAYS
3. PROVIDE CONTROL JOINTS @ 400 SQ FT. MAXIMUM SLABS
4. WALLS AND DRIVES - 2500 P.S.I. @ 28 DAYS
5. LANDINGS AT ALL EXTERIOR DOOR LOCATIONS SHALL HAVE A MAXIMUM SLOPE OF 1/4" PER FOOT.
6. SEAL ALL VOIDS AROUND PENETRATIONS IN FLOOR SLABS AND WALLS
7. FOUNDATION WALLS (CMU OR POURED) SHALL NOT BE CONSTRUCTED DURING FREEZING WEATHER UNLESS PROPERLY PROTECTED IN ACCORDANCE WITH THE MOST RECENT MIA OR ADO RECOMMENDATIONS.
8. CRANKSPACE FOUNDATION WALLS SHALL BE MOISTURE-PROOFED FROM TOP OF FOOTING TO FINISH GRADE. INSTALL POSITIVE DRAIN & VAPOR BARRIER IN CRANKSPACE, INSTALL 4" FOUNDATION DRAIN AT TOP OF FOOTING SLOPED TO DRAIN AT GRADE.
9. BASEMENT FOUNDATION WALLS SHALL BE MOISTURE-PROOFED FROM TOP OF FOOTING TO FINISH GRADE. INSTALL 1/2" PROTECTION BOARD AGAINST WATERPROOFING MEMBRANE. INSTALL 6" FOUNDATION DRAIN AT TOP OF FOOTING SLOPED TO DRAIN AT GRADE. REMOVE ALL CONSTRUCTION DEBRIS IN FOUNDATION TRENCH PRIOR TO BACKFILL. ADD GRAVEL IN 12" LIFTS, TO WITHIN 24" FIN. GRADE.

MASONRY:

1. CONCRETE BLOCK UNITS - GRADE N: FM - 1350 P.S.I.
2. GROUT - 3000 P.S.I.
3. MORTAR TYPE S - 1800 P.S.I.
4. ALL CELLS WITH REBAR TO BE GROUTED SOLID.

LUMBER:

1. ALL SAWN LUMBER SHALL BEAR STAMP OR SWPA OR APPROVED TESTING AGENCY.
2. ROOF JOISTS, FLOOR JOISTS, LEDGERS AND PLATES TO BE SOUTHERN YELLOW PINE.
3. STUDS TO BE SOUTHERN YELLOW PINE STUD GRADE, OR APPROVED EQUAL.

PLYWOOD:

1. ROOF PLYWOOD SHALL BE 1/2" EXTERIOR GRADE SHEATHING (5-PLY) W/ EXTERIOR GLUE. INDEX 40/20 WITH STAMP OF APPROVED TESTING AGENCY.
2. FLOOR PLYWOOD 3/4" TONGUE & GROOVE UNDERLAYMENT (48/24) GROUP 1 W/ EXTERIOR GLUE WITH STAMP OF APPROVED TESTING AGENCY.
3. FLOOR PLYWOOD SHALL BE GLUED TO JOISTS AND SCREW ATTACHED. ALL PLYWOOD EDGES SHALL REST FIRMLY ON JOISTS.
4. WALL PLYWOOD SHALL BE 1/2 STANDARD SHEATHING (5-PLY) W/ EXTERIOR GLUE. INDEX 40/20 WITH STAMP OF APPROVED TESTING AGENCY.

ROOF FRAMING:

1. PLYWOOD DECKING EDGES SHALL BEAR ON ROOF FRAMING MEMBERS & BUTT ALONG THEIR CENTER LINES WITH PANEL EDGES STAGGERED AND FACE GRAN PERPENDICULAR TO SUPPORT.

WALL FRAMING:

1. ALL BEARING STUD WALLS TO BE 2X6 @ 16" O.C. @ BASEMENT & 2X4 @ 16" O.C. ELSEWHERE. EXCEPT AS NOTED, PROVIDE FULL DEPTH 2X SOLID BLOCKING OR BLOCKING PANELS BETWEEN FRAMING MEMBERS AT ALL BEARING POINTS.
2. ALL BEARING PARTITIONS SHALL HAVE DOUBLE TOP PLATES.
3. THE EXTERIOR SIDE OF ALL EXTERIOR WALLS SHALL BE BRACED AT EACH END OF INSIDE AND OUTSIDE CORNERS AND BRACED AT LEAST EVERY 25' @ IN HORIZONTAL LENGTH. WHERE 1X4 LET-IN BRACING OR METAL "X" BRACING CANNOT BE UTILIZED DUE TO OPENINGS, PROVIDE A MINIMUM OF 3/8" PLYWOOD SHEATHING FOR BRACING FROM THE CORNER TO 4' OF BEYOND THE WALL OPENING (OR TO THE NEXT CORNER, WHICHEVER COMES FIRST.)
4. FIRE BLOCK STUD WALLS AT ALL DROPPED CEILINGS, SOFFITS, TOPS OF FRAMED COLUMNS, AND AT INTERVALS PER GOVERNING CODES CITED ABOVE.
5. CUTTING, NOTCHING, AND DRILLING OF WOOD MEMBERS SHALL COMPLY WITH GOVERNING CODES CITED ABOVE.

NAILING SCHEDULE:

1. SEE FASTENER SCHEDULE FOR STRUCTURAL MEMBERS PER GOVERNING CODES CITED ABOVE.
2. EXTERIOR SIDING SHALL BE ATTACHED TO FRAMING IN STRICT ACCORDANCE WITH MFR. REQUIREMENTS AT EDGES AND 12" O.C. AT INTERMEDIATE SUPPORTS.
3. ALL FASTENERS, WHETHER NAILS, SCREWS, ANCHORS, ETC. SHALL BE SIZED APPROPRIATE FOR THE INTENDED USE. IN CORRECT NUMBER AND SPACING, AND OF MATERIAL COMPOSITION COMPATIBLE WITH MATERIALS THAT ARE ATTACHED THEREBY. ABSOLUTELY NO DISSIMILAR METALS ALLOWED.

FLOOR FRAMING:

1. DRILLING AND NOTCHING OF FLOOR JOISTS SHALL COMPLY WITH GOVERNING CODES CITED ABOVE.
2. ALL WOOD MEMBERS IN CONTACT WITH CONCRETE, MASONRY, OR WITHIN 8" OF GRADE SHALL BE PRESURE TREATED.
3. ALL PLATES SHALL BE ANCHORED TO THE FOUNDATION. USE 1/2" ANCHOR BOLTS SPACED @ 6"-0" O.C. MAXIMUM.
4. ALL CONVENTIONAL FRAMING SHALL COMPLY WITH OR EXCEED, REQUIREMENTS OF GOVERNING CODES CITED ABOVE.

INSULATION:

1. MINIMUM INSULATION SHALL BE PROVIDED AS FOLLOWS:
FLOORS ABOVE A CRAWLSPACE R-19/6" FIBERGLASS BATTS
EXTERIOR FRAMED WALLS R-13/3 1/2" FIBERGLASS BATTS
ATTIC / VAULTED ROOFS R-30/9" FIBERGLASS BATTS
2. INSTALL VAPOR BARRIER AT "WARM SIDE" OF EXTERIOR WALLS. FULLY CAULK ALL JOINTS, 1% & CORNERS.
3. INSTALL TYVEK OVER EXTERIOR SHEATHING.

GLASS:

1. THE WINDOWS NOTED ON THESE PLANS DEPICT VINYL RESIDENTIAL WINDOW AND DOOR UNITS. IF OTHER WINDOWS ARE USED, CONSULT WITH OWNER & THE WINDOW SUPPLIER TO DETERMINE COMPATIBLE ALTERNATIVES FOR THIS PARTICULAR INSTALLATION. ALL WINDOW AND DOOR UNITS, REGARDLESS OF MFCR, SHALL COMPLY WITH REQUIREMENTS FOR ROUGH OPENING SIZES, EGRESS, LIGHT, AND VENTILATION.
2. SHOWER ENCLOSURES EQUIPPED WITH SHOWER DOORS SHALL BE TEMPERED GLASS OR APPROVED EQUAL.
3. ALL WINDOWS, AND DOORS WITH GLAZING, SHALL BE DOUBLE GLAZED.
4. ALL GLASS IN HAZARDOUS LOCATIONS, INCLUDING WITHIN A 24" ARC OF ANY ACTIVE DOOR AND ALL GLASS WITHIN 18" OF FLOOR SHOULD BE SAFETY GLASS.
5. WHERE EGRESS OPENINGS ARE REQUIRED, PROVIDE AN OPERABLE WINDOW OR DOOR WITH AN AREA OF 5.7-50 FT. (MINIMUM) OPENING DIRECTLY TO THE OUTSIDE WITH MINIMUM NET CLEAR OF 20" WIDE AND 24" HIGH. EXCEPTION: GRADE LEVEL BEDROOMS MINIMUM OPENING MAY BE 5.0 SQ FT.

INTERIOR MATERIALS - DRYWALL:

1. VANITY AREA: INSTALL 1/2" DRYWALL AT BOTH CEILING AND WALLS. DRYWALL TO BE SCREW ATTACHED TO STUD FRAMING. INSTALL SO AS TO MINIMIZE THE NUMBER OF JOINTS.
2. TOILET AND SHOWER WALLS SHALL BE FINISHED WITH 1/2" WATER RESISTANT DRYWALL. INSTALL WITH MINIMUM NUMBER OF JOINTS.
3. ALL DRYWALL TO RECEIVE 3 COATS OF DRYWALL COMPOUND WITH SANDING BETWEEN EACH APPLICATION. INSTALL CORNER BEADS AT ALL CORNER CONDITIONS AND TAPE AT LOCATIONS SUBJECT TO EXCESSIVE MOVEMENT OR SETTLEMENT. AT FINAL COAT, UTILIZE 500K LIGHT TO DETECT & CORRECT SURFACE IMPERFECTIONS IN THE DRYWALL FINISH.

INTERIOR MATERIALS - SHOWER WALLS & FLOOR:

4. INSTALL CERAMIC TILE, MARBLE TILE, (OR MATERIAL SELECTED BY OWNER) TO A MINIMUM HEIGHT OF 7'-0" ABOVE DRAIN.
5. VERIFY SUPPORT REQUIREMENTS FOR WOOD JOISTS SUPPORTING CERAMIC TILE, STONE OR MARBLE FLOOR MATERIAL. INSTALL MARBLE TILES AT SHOWER / TOILET ROOM USING THIN-SET METHOD. PROVIDE MARBLE TRANSITION STRIP AT THRESHOLD OF BOTH DOORS INTO VANITY AREAS. AT OWNERS OPTION THICK-SET INSTALLATION MAY BE UTILIZED, HOWEVER, ADJUST FRAMING LEVEL ACCORDINGLY.

INTERIOR MATERIALS - DOORS & HARDWARE:

6. ALL FIRST FLOOR DOORS TO BE 6'-0" OR 6'-0" TALL, 1 3/8" INTERIOR HOLLOW CORE COMPLETE WITH HARDWARE:
2 PR. BUTTS, PRIVACY SET AND DOOR STOP PER EACH DOOR. HARDWARE SELECTED BY OWNER.
7. ALL SECOND FLOOR DOORS TO BE 6'-8" TALL, 1 3/8" INTERIOR HOLLOW CORE COMPLETE WITH HARDWARE:
1 1/2 PR. BUTTS, PRIVACY SET AND DOOR STOP PER EACH DOOR. HARDWARE SELECTED BY OWNER.
8. CLOSET, STORAGE AND UTILITY ROOM DOORS TO HAVE "DUMMY" LOCKSETS AND MAGNETIC BALL CATCHES. ALL EXTERIOR DOORS TO HAVE DEADBOLT LOCK AND FULL WEATHERSTRIPPING AND DOOR SWEEP.

INTERIOR MATERIALS - BASE TRIM AND CASING:

9. INTERIOR DOOR AND WINDOW CASING FOR PAINT APPLICATION TO BE HOMEOWNER OR BUILDER'S SELECTION. INSTALL WINDOW CASING WITH SILL AND APRON. THOROUGHLY PREP ALL TRIM; FILLING HOLES AND JOINTS. REPLACE DAMAGED MATERIAL, AND SAND SMOOTH, PRIOR TO PAINT APPLICATION.
10. INTERIOR BASEBOARD FOR PAINT APPLICATION TO BE HOMEOWNER OR BUILDER'S SELECTION.

INTERIOR MATERIALS - PAINT & PAPER:

11. PAINT TO BE SELECTED BY OWNER. APPLY PRIMER COAT AND 2 FINISH COATS, SANDING LIGHTLY BETWEEN EACH COAT. APPLY PIGMENTED SHEL-LAC TO COVER KNOTS & OTHER SURFACE IMPERFECTIONS IN TRIM. USE PAINT FORMULATED FOR MOST LOCATIONS. SURFACES TO RECEIVE WALLPAPER TO BE SIZED. TRIM PAINT: HIGH GLOSS, OIL BASE. WALL PAINT: LATEX, SEMI-GLOSS OR EGGSHELL. CEILING PAINT: LATEX, SEMI-GLOSS OR EGGSHELL.

EXTERIOR MATERIALS:

1. STONE AND HARD PLANK VENEER WITH GRAPEVINE JOINT, OR AS SELECTED BY OWNER.
2. S. TAB. ARCHITECTURAL SHINGLES, SLATE LINE, OR AS SELECTED BY OWNER.
3. ARCHITECTURAL COLUMNS BY HARTMAN-SANDERS, OR AS SELECTED BY OWNER.
4. SIDING MATERIAL @ REAR & SIDES.

EXTERIOR FINISH:

1. BRICK - CLEAN VENEER OF EXCESS MORTAR, INSPECT JOINTS & TOUCH UP AS REQUIRED.
2. EXTERIOR TRIM - STAIN & PAINT.
3. WINDOW TRIM - VINYL OR WOOD WINDOWS & TRIM.
4. SIDING - HARDI-BOARD (COLOR SELECTED BY OWNER).
5. STONE VENEER - CLEAN VENEER OF EXCESS MORTAR, INSPECT JOINTS & TOUCH UP AS REQUIRED.

FLASHING MATERIALS:

1. INSTALL CONCEALED FLASHING AT ALL LOCATIONS WHERE EXTERIOR MATERIAL IS SIDING, STUCCO, OR OTHER NON-MASONRY CONSTRUCTION. INSTALL BACKER ROD AND CAULK TO MAKE WATERTIGHT.
2. INSTALL CONCEALED THRU-WALL FLASHING AT EACH OPENING IN EXTERIOR WALL. FLASH BOTH HEAD AND SILL CONDITIONS. INSTALL BACKER ROD AND CAULK TO MAKE WATERTIGHT.
3. INSTALL FLASHING AT ALL LOCATIONS WHERE ROOFING BUTS A MASONRY WALL SURFACE AND EXTERIOR OPENINGS TO UTILIZE NO DISSIMILAR METALS. PROTECT FROM CONTACT BY APPLIED COATING.

GUTTERS AND DOWNSPOUTS:

1. INSTALL MINIMUM 6" ALUMINUM GUTTERS, OGEE PROFILE. GUTTERS SHALL BE INSTALLED TO DRAIN ROOF AREAS OF RAINFALL INTENSITY AMOUNTS AS EVIDENCED IN LOCAL RECORDS.
2. DOWNSPOUTS DRAINING ROOF AREAS TO TERMINATE AT PRE-FORMED SPLASH BLOCKS, OR INTO UNDERGROUND PIPING WHICH CARRIES RAINFALL RUN-OFF INTO APPROVED STORM DRAINAGE SYSTEM.

MECHANICAL:

1. ALL NEW DUCTWORK TO BE INSULATED MATERIAL, OR AS SELECTED BY OWNER. DUCTWORK, SECURED TO FLOOR FRAMING BY METAL STRAPS.
2. INSTALL ELECTRICALLY POWERED EXHAUST VENT AT SHOWER AREA (OPTIONAL), EXTEND DUCT THROUGH TO EXTERIOR, FLASHING AND CAP. PAINT VENT STACK TO MATCH SHINGLE COLOR.
3. INSTALL FLOOR REGISTERS MFCR. BY "REGGIO", OR AS SELECTED BY OWNER.

PLUMBING: (OWNER TO SELECT FIXTURES)

1. WATER CLOSETS - GRAVITY: 1.6 GALLON/FLUSH MAXIMUM
2. SHOWER HEADS - 2.75 GALLON/MINUTE MAXIMUM
3. LAVATORY FAUCETS - 3.0 GALLON/MINUTE
4. ALL WATER SUPPLY PIPE MATERIAL TO BE PVC, INSTALLATION AS PER LOCAL CODE
5. ALL WASTE AND VENT PIPE MATERIAL TO BE PVC, INSTALLATION AS PER LOCAL CODE.
6. SOLDER AND FLUX HAVING A LEAD CONTENT IN EXCESS OF TWO TENTHS OF ONE PERCENT SHALL NOT BE USED IN THE INSTALLATION OR REPAIR OF PLUMBING RESIDENTIAL OR NONRESIDENTIAL OR FACILITIES PROVIDING WATER OF HUMAN CONSUMPTION WHICH ARE CONNECTED TO PUBLIC WATER SYSTEMS.

ELECTRICAL:

1. ELECTRICAL SERVICE PER PREVAILING LOCAL, STATE AND NATIONAL ELECTRIC CODES.
2. ALL OUTLET BOXES SHALL BE RIGIDLY SECURED IN PLACE. VERIFY LOCATIONS WITH OWNER PRIOR TO INSTALLATION. CENTER ELECTRICAL DEVICES WHERE POSSIBLE.
3. ALL 110 V RECEPTACLES TO BE GFI TYPE DEVICES IN WET AREAS. OUTLETS AND SWITCHES TO BE WHITE WITH MATCHING COVER PLATES.

SMOKE DETECTORS:

1. SMOKE DETECTOR SHALL BE PERMANANTLY WIRED, INTERCONNECTED AND HAVE BATTERY POWERED BACK-UP.
2. SMOKE DETECTORS (SD) SHALL BE PLACED NO MORE THAN 12'-0" ABOVE THE FINISHED FLOOR LEVEL AND NO CLOSER THAN 3'-0" FROM DUCT OPENINGS. LOCATION OF SMOKE DETECTORS SHALL BE PER GOVERNING CODES.

GENERAL NOTES:

ALL BUILDING AND GARAGE DIMENSIONS SHOWN PROVIDED BY CLIENT.

GRADING AND EROSION CONTROL NOTES:

1. MINIMUM SLOPE AT GRASS OR LANDSCAPED AREAS WITHIN 5' OF THE PROPOSED BUILDING SHALL BE SIX AWAY FROM STRUCTURE.
2. POSITIVE DRAINAGE SHALL BE PROVIDED AWAY FROM ANY HVAC UNITS.
3. ALL FILL SHALL BE COMPACTED TO BUILDING CODE STANDARDS.
4. STABILIZE ALL DISTURBED AREAS WITH TOPSOIL, SEEDING, AND STRAW OR ECB IF SHOWN WITHIN 14 DAYS OF COMPLETING FILL ON LOT.
5. ALL EROSION CONTROLS MEASURES EXCEPT ECB/SOD SHALL BE INSTALLED PRIOR TO BEGINNING CONSTRUCTION.
6. SUBJECT PROPERTY IS NOT LOCATED WITHIN THE 100 YEAR FLOODZONE AS EVIDENCED IN FEMA MAP 4703700200F EFFECTIVE DATE 4-20-01.

OWNER:
MARGUERITA JACKSON
4417 BRIDGEMAN AVENUE
NASHVILLE, TENNESSEE 37207

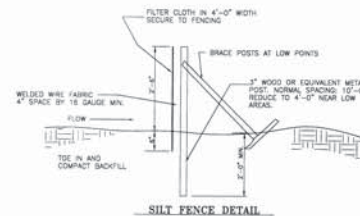

SILT FENCE DETAIL

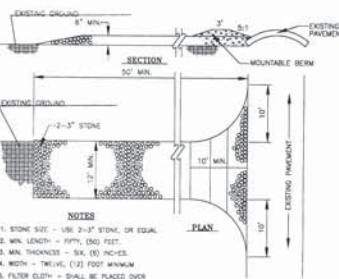

- NOTES**
1. STONE SIZE - USE 2-3" STONE, OR EQUAL.
 2. MIN. LENGTH - FIFTY (50) FEET.
 3. MIN. THICKNESS - SIX (6) INCHES.
 4. WIDTH - TWELVE (12) FOOT MINIMUM.
 5. FILTER CLOTH - SHALL BE PLACED OVER THE ENTIRE AREA PRIOR TO PLACING OF STONE.
 6. SURFACE WATER - ALL SURFACE WATER FLOWING OR DIVERTED TOWARD CONSTRUCTION ENTRANCES SHALL BE PIPED ACROSS THE ENTRANCE.
 7. MAINTENANCE - THE ENTRANCE SHALL BE MAINTAINED IN A CONDITION WHICH WILL PREVENT TRACKING OR FLOWING OF SEDIMENT ONTO PUBLIC RIGHTS-OF-WAY. THIS MAY REQUIRE PERIODIC TOP DRESSING WITH ADDITIONAL STONE AS CONDITIONS DEMAND, AND REPAIR AND/OR CLEANOUT OF ANY MEASURES USED TO TRAP SEDIMENT. ALL SEDIMENT SPILLED, SWIPPED, WASHED OR TRACKED ONTO PUBLIC RIGHTS-OF-WAY SHALL BE REMOVED IMMEDIATELY.

TEMPORARY CONSTRUCTION ENTRANCE

STORMWATER NOTES:

1. ANY EXCAVATION, FILL OR DISTURBANCE OF THE EXISTING GROUND ELEVATION MUST BE DONE IN ACCORDANCE WITH STORM WATER MANAGEMENT ORDINANCE NO. 78/840 AND APPROVED BY THE METROPOLITAN DEPARTMENT OF WATER SERVICES.
2. THIS DRAWING IS FOR ILLUSTRATION PURPOSES TO INDICATE THE BASIC PREMISE OF THE DEVELOPMENT, THE FINAL LOT COUNT AND DETAILS OF THE PLAN SHALL BE GOVERNED BY THE APPROPRIATE REGULATIONS AT THE TIME OF THE FINAL APPLICATION.
3. METRO WATER SERVICES SHALL BE PROVIDED SUFFICIENT AND UNOBSCURED ACCESS IN ORDER TO MAINTAIN AND REPAIR UTILITIES IN THIS SITE.
4. SIZE DRIVEWAY CULVERTS PER THE DESIGN CRITERIA SET FORTH BY THE METRO STORMWATER MANAGEMENT MANUAL (MINIMUM 15" CMP.)

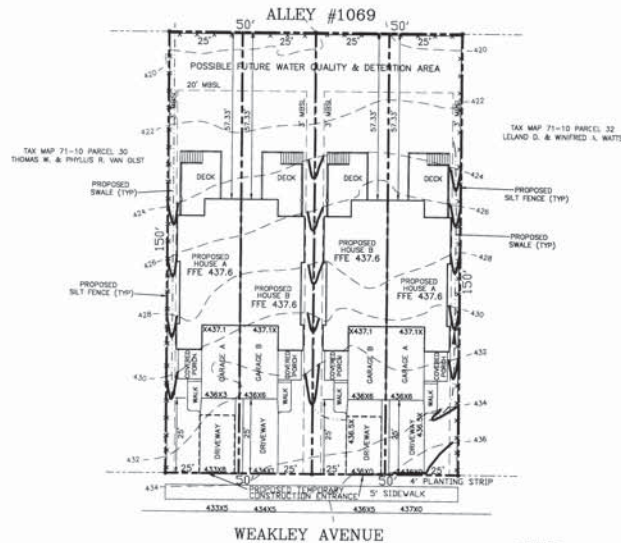

WEAKLEY AVENUE

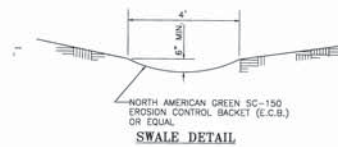

SWALE DETAIL



CASE NO. 2014SP-084-001
GRADING PLAN
519 & 521 WEAKLEY AVENUE
2ND COUNCILMANIC DISTRICT
NASHVILLE-DAVIDSON COUNTY-TENNESSEE
SCALE: 1"=20' DATE: 10-25-14
REV: 11-21-14

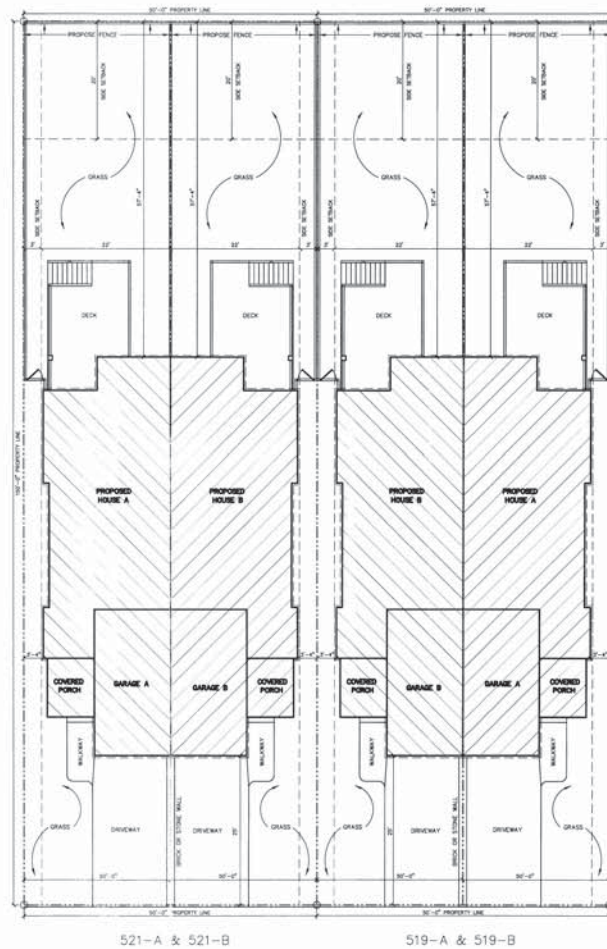

521-A & 521-B

519-A & 519-B

WEAKLEY AVENUE

SITE/PLOT PLAN
SCALE - 1" = 10'- 0"

REVISIONS	

NOTES: This set of drawings for a custom home is the copyrighted property of JKH DESIGN. This single copy is loaned pursuant to the terms and conditions of the design agreement and no right to reproduce or copy any part of the plans.

These drawings are not to be reproduced by anyone or any method, including: blueprinting, scanning, photography, tracing, re-drawing, or other means. They may not be used by anyone for repeat construction, resale, alteration, completion, or any other purpose, without written consent of JKH DESIGN.

They may not knowingly be furnished to others for any purpose. They have been prepared by JKH DESIGN as an independent contractor and not as an employee of owner. All original tracings prepared by JKH DESIGN will remain in the office.

JKH DESIGN, 2013

JKH DESIGN ARCHITECTURAL

JURTI HALL
3919 Henricks Hill Drive
Smyrna, Tennessee 37167
Phone: 615-405-0310
jkhdesign@comcast.net / www.jkhdesign.t.com

A NEW TOWNHOMES FOR:

MARGUERITA JACKSON
519 A & B WEAKLEY AVENUE
AND
521 A & B WEAKLEY AVENUE
NASHVILLE, TN 37207

Drawn	JKH
Checked	JLM
Filename	1.0
Issued	8-15-14

A-1.0

EXTERIOR ELEVATION NOTES:

1. IF USING 6'-0" EXTERIOR DOORS, WINDOWS NEED TO BE AT A HEADER HEIGHT OF 88',8"-2".
2. IF USING 7'-0" EXTERIOR DOORS W/12" TRANSOM, WINDOWS NEED TO BE AT A HEADER HEIGHT OF 100'8"-4".
3. IF USING 6'-8" EXTERIOR DOORS W/12" TRANSOM, WINDOWS NEED TO BE AT A HEADER HEIGHT OF 88',8"-2".
4. USE STICKY FELT(UNDER SHINGLES) ON ANY SLOPE UNDER 4/12 PITCH.
5. INSTALL METAL FLASHING AT ALL OPENINGS IN EXTERIOR WALLS, I.E. WINDOWS, DOORS, GABLE VENTS, DORMERS, ETC. INSTALL EXTERIOR BUILDING WRAP (TYVEK OR APPROVED EQUAL) OVER SHEATHING, TAPE ALL JOINTS, EDGES, AND TEARS. TYPICAL FLASHING LOCATIONS INCLUDE: THRU-WALL, HEAD FLASHING, SILL FLASHING, FLASHING AT WALL/ROOF INTERSECTIONS, CHIMNEY CAP, ETC.
6. INSTALL WEEP HOLES AT BASE OF EXTERIOR MASONRY WALLS ABOVE FINISH GRADE. SPACE WEEPS AT 24" O.C. KEEP AIR SPACE CLEAR OF MORTAR TO INSURE AIR FLOW IN CAVITY.
7. INSTALL 6" OGGE QUITTERS RECTANGULAR DOWNSPOUTS FOR ROOF DRAINAGE. TERMINATE DOWNSPOUTS AT SPLASHBLOCKS. PROVIDE DIVERSIFIERS AND END CAPS.



REAR



FRONT

REVISIONS	

DISCLAIMER: This set of drawings for a custom home is the intellectual property of JDI DESIGN. This might vary in detail pursuant to the terms and conditions of the design agreement and no right to reproduce or copy any portion of the plans.

These drawings are not to be reproduced by anyone or by method including, but not limited to, duplicating, scanning, photographing, tracing, re-drawing, or other means. They may not be used by anyone for repeat construction, sales brochures, advertising, or any other purpose, without written consent of JDI DESIGN.

They may not knowingly be furnished to others for such purposes. They have been prepared by JDI DESIGN as an independent contractor and not as an employee or agent. All original drawings prepared by JDI DESIGN will remain in the office.

JDI DESIGN, 2013

JDI DESIGN ARCHITECTURAL
JURRI HALL
 3919 Herricks Hill Drive
 Smyrna, Tennessee 37167
 Phone: 615-405-0310
 jdi.design@comcast.net / www.jdidesign.com

A NEW TOWNHOMES FOR:
MARGUERITA JACKSON
 519 A & B WEAKLEY AVENUE
 AND
 521 A & B WEAKLEY AVENUE
 NASHVILLE, TN 37207

Drawn	JDI
Checked	JLM
Filename	1.1
Issued	8-15-14

ELEVATION'S
 SCALE: - 1/4" = 1'- 0"

A-1.1

EXTERIOR ELEVATION NOTES:

1. IF USING 6'-2" EXTERIOR DOORS, WINDOWS NEED TO BE AT A HEADER HEIGHT OF 98'8"-2".
2. IF USING 7'-0" EXTERIOR DOORS W/12" TRANSOM, WINDOWS NEED TO BE AT A HEADER HEIGHT OF 100'8"-4".
3. IF USING 6'-8" EXTERIOR DOORS W/12" TRANSOM, WINDOWS NEED TO BE AT A HEADER HEIGHT OF 98'8"-2".
4. USE STICKY FELT(UNDER SHINGLES) ON ANY SLOPE UNDER 4/12 PITCH.
5. INSTALL METAL FLASHING AT ALL OPENINGS IN EXTERIOR WALLS, I.E. WINDOWS, DOORS, GABLE VENTS, DORMERS, ETC. INSTALL EXTERIOR BUILDING WRAP (THICK OR APPROVED EQUAL) OVER SHEATHING TAPE ALL JOINTS, EDES, AND TEARS. TYPICAL FLASHING LOCATIONS INCLUDE: THRU-WALL, HEAD FLASHING, SILL FLASHING, FLASHING AT WALL/ROOF INTERSECTIONS, CHIMNEY CAP, ETC.
6. INSTALL KEEP HOLES AT BASE OF EXTERIOR MASONRY WALLS ABOVE FINISH GRADE. SPACE KEEPS AT 24" O.C. KEEP AIR SPACE CLEAR OF MORTAR TO INSURE AIR FLOW IN CAVITY.
7. INSTALL 6" OGEZ GUTTERS RECTANGULAR DOWNSPOUTS FOR ROOF DRAINAGE. TERMINATE DOWNSPOUTS AT SPLASHBLOCKS. PROVIDE INVERTORS AND END CAPS.



NO.	DESCRIPTION	DATE

NOTES: This set of drawings for a custom home is the copyrighted property of JDH DESIGN. This single copy is licensed pursuant to the terms and conditions of the design agreement and no right to reproduce or copy any portion of the plans.

These drawings are not to be reproduced by anyone or any method, including: blueprinting, scanning, photographing, tracing, re-drawing, or other means. They may not be used by anyone for repeat construction, resale, production, advertising, or any other purpose, without written consent of JDH DESIGN.

They may not knowingly be furnished to others for such purposes. They have been prepared by JDH DESIGN as an independent contractor and not as an employee of owner. All original tracings prepared by JDH DESIGN will remain in the office.

JDH DESIGN, 2013

JDH DESIGN ARCHITECTURAL
JURIE HALL
 3919 Henricks Hill Drive
 Smyrna, Tennessee 37167
 Phone: 615-400-0310
 jdhdesign@comcast.net / www.jdhdesign-3.com

A NEW TOWNHOMES FOR:
MARGUERITA JACKSON
 519 A & B WEAKLEY AVENUE
 AND
 521 A & B WEAKLEY AVENUE
 NASHVILLE, TN 37207

Drawn	JDH
Checked	JLM
Filename	1.2
Issued	8-15-14

RIGHT ELEVATION
 SCALE - 1/4" = 1'-0"

A-1.2

EXTERIOR ELEVATION NOTES:

1. IF USING 8'-0" EXTERIOR DOORS, WINDOWS NEED TO BE AT A HEADER HEIGHT OF 98"/8'-2".
2. IF USING 7'-0" EXTERIOR DOORS 4/12" TRANSOM, WINDOWS NEED TO BE AT A HEADER HEIGHT OF 100"/8'-4".
3. IF USING 6'-8" EXTERIOR DOORS 4/12" TRANSOM, WINDOWS NEED TO BE AT A HEADER HEIGHT OF 98"/8'-2".
4. USE STICKY FELT(UNDER SHINGLES) ON ANY SLOPE UNDER 4/12 PITCH.
5. INSTALL METAL FLASHING AT ALL OPENINGS IN EXTERIOR WALLS, I.E. WINDOWS, DOORS, GABLE VENTS, CORNERS, ETC. INSTALL EXTERIOR BUILDING WRAP (TYP. OR APPROVED EQUAL) OVER SHEATHING TAPE ALL JOINTS, EDGES, AND TEARS. TYPICAL FLASHING LOCATIONS INCLUDE: THRU-WALL HEAD FLASHING, SILL FLASHING, FLASHING AT WALL/ROOF INTERSECTIONS, CHIMNEY CAP, ETC.
6. INSTALL WEEP HOLES AT BASE OF EXTERIOR MASONRY WALLS ABOVE FINISH GRADE. SPACE WEEPS AT 24" O.C. KEEP AIR SPACE CLEAR OF WORKER TO INSURE AIR FLOW IN CAVITY.
7. INSTALL 6" OEE OUTTERS RECTANGULAR DOWNSPOUTS FOR ROOF DRAINAGE. TERMINATE DOWNSPOUTS AT SPLASH-BLOCKS. PROVIDE DIVERTORS AND END CAPS.



REVISIONS	

This set of drawings for a custom home is the copyrighted property of JKH DESIGN. This single copy is licensed pursuant to the terms and conditions of the design agreement and no right is reproduced or copy any portion of the plans.

These drawings are not to be reproduced by anyone or any method including, but not limited to, scanning, photocopying, tracing, re-drawing, or other means. They may not be used by anyone for repeat construction, resale, alteration, or any other purpose, without written consent of JKH DESIGN.

They may not knowingly be furnished to others for such purposes. They have been prepared by JKH DESIGN as an independent contractor and not as an employee of owner. All original tracing prepared by JKH DESIGN will remain in the office.

JKH DESIGN, 2013

JKH DESIGN ARCHITECTURAL
JURRI HALL
 3919 Henricks Hill Drive
 Smyrna, Tennessee 37167
 Phone: 615-405-0310
 jkhdesign@comcast.net / www.jkhdesign3.com

A NEW TOWNHOMES FOR:
MARGUERITA JACKSON
 519 A & B WEAKLEY AVENUE
 AND
 521 A & B WEAKLEY AVENUE
 NASHVILLE, TN 37207

Drawn	JKH
Checked	JLM
Filename	1_3
Issued	8-15-14

LEFT ELEVATION
 SCALE - 1/4" = 1'-0"

A-1.3

FOUNDATION NOTES:

1. step foundation stone ledge to accommodate changes in grade elevation.
2. abutle joints under all partial partitions, regardless of length
3. crossbridle all spans over 10'-0"
4. provide crawspace demoproofing w/8" drain to grade
5. 24" wide x 12" deep concrete (3000 P.S.I. min.) footing with 2 #4's cont. (top bars 24" @ corners & splices) typical at ground unless noted.
6. install rebar w/spacing below slab continuous thru footing connected to rebar vent stack. stack to terminate above finished roof
7. floor framing to be T.J.L.'s o.c. unless noted otherwise
8. lv beams to be installed in strict compliance w/mtor requirements
9. 4" thick concrete garage slip with 8" x 8" w/d/10 waf over 5 mil. polythene over 4" crushed stone on compacted base.
10. 5 mil. poly. vapor/moisture barrier over entire crawl space area.
11. apply termite proofing solution over entire crawl space and/or under all floor slabs.
12. Do not issue drawings. contractor must verify all dimensions prior to start of construction. notify architect immediately of any discrepancies.

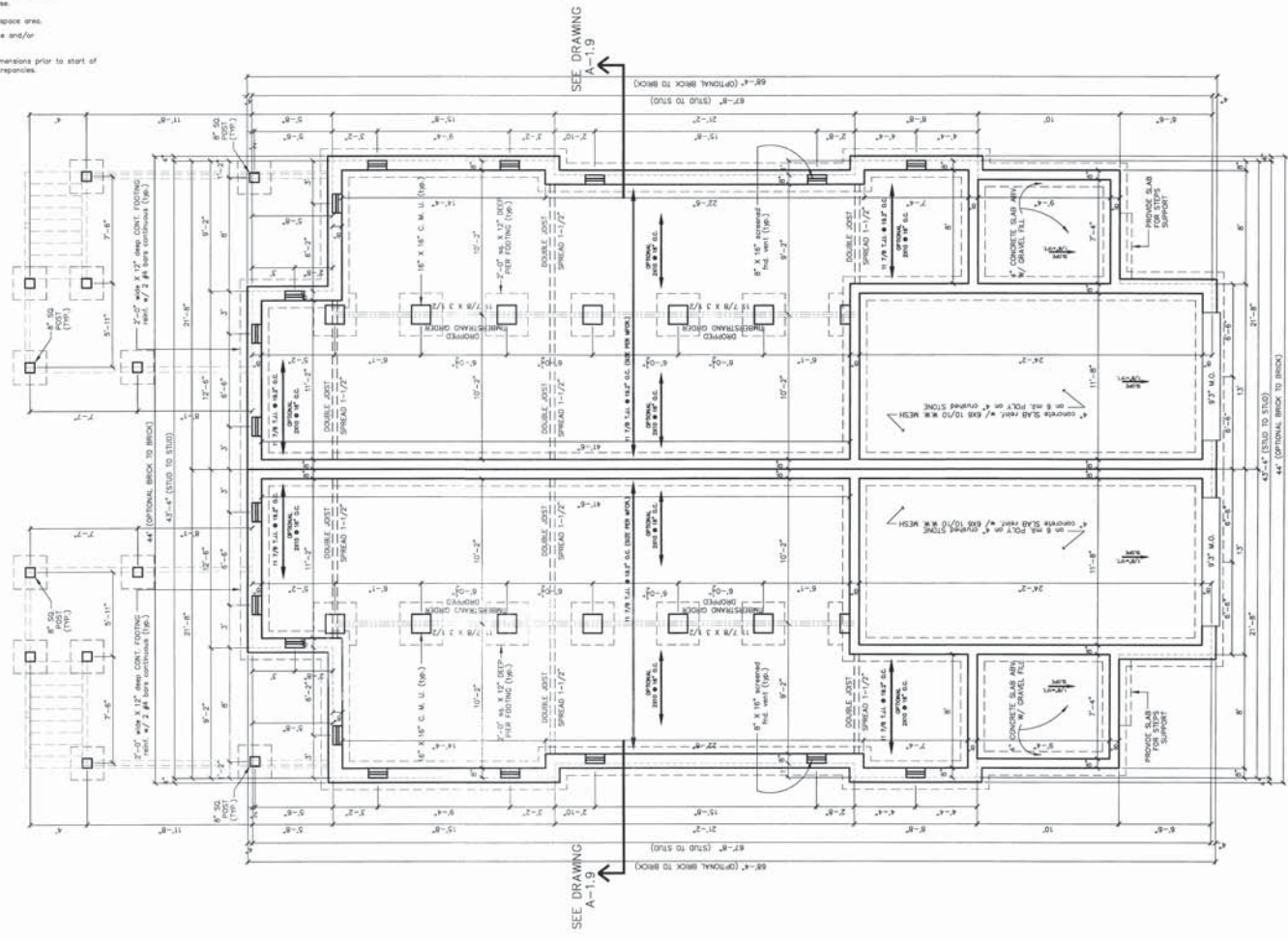

SEE DRAWING A-1.9

SEE DRAWING A-1.9

FOUNDATION PLAN
SCALE - 1/4" = 1' - 0"

REVISIONS

NO.	DESCRIPTION

NOTICE: This set of drawings for a custom home is the copyrighted property of JDH DESIGN. This work may be limited pursuant to the terms and conditions of the design agreement and no right to reproduce or copy any portion of the plans.

These drawings are not to be reproduced by anyone or any method, including blueprinting, scanning, photocopying, tracing, re-drawing, or other means. They may not be used by anyone for repeat construction, sales brochures, advertising, or any other purposes, without written consent of JDH DESIGN.

They may not knowingly be furnished to others for such purposes. They have been prepared by JDH DESIGN as an independent contractor and not as an employee of owner. All original tracings prepared by JDH DESIGN will remain in the office.

JDH DESIGN, 2013

JDH DESIGN ARCHITECTURAL
JULIE HALL
3919 Henricks Hill Drive
Smyrna, Tennessee 37167
Phone: 615-405-0310
jdhdesign@comcast.net / www.jdhdesign-3.com

A NEW TOWNHOMES FOR:
MARGUERITA JACKSON
519 A & B WEAKLEY AVENUE
AND
521 A & B WEAKLEY AVENUE
NASHVILLE, TN 37207

Drawn	JDH
Checked	J.M
Filename	1.4
Issued	8-15-14

A-1.4



TYP. MASTER SHOWER DETAIL
SCALE: N.T.S.

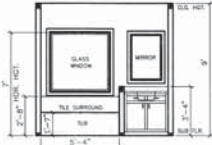

TYP. MASTER TUB & VANITY DETAIL
SCALE: N.T.S.

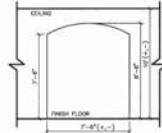

TYP. ARCH OPENING
SCALE - N.T.S. (NO CASING)

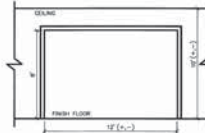

TYP. CASED OPENING
SCALE - N.T.S.

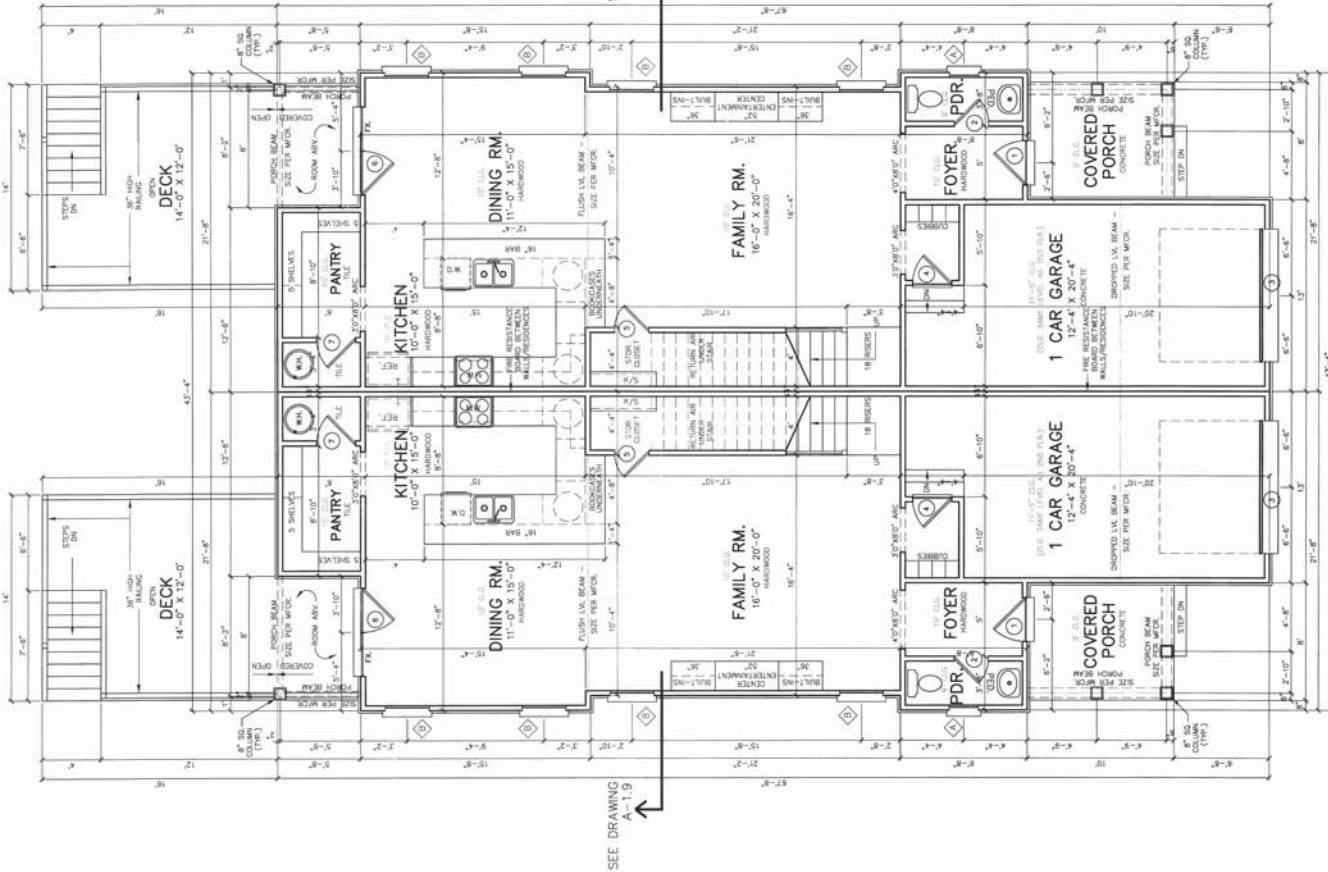

DOOR SCHEDULE			
NO.	WIDTH	HEIGHT	DESCRIPTION
1	2'-0"	8'-0"	EXTERIOR INSULATED WOOD 8 LITE GLASS DOOR W/ PANEL
2	2'-4"	8'-0"	INTERIOR 2 PANEL DOOR
3	8'-0"	8'-0"	INSULATED GARAGE DOOR W/ GLASS PANEL
4	2'-0"	8'-0"	INSULATED INTERIOR 2 PANEL DOOR
5	2'-4"	8'-0"	INTERIOR 2 PANEL DOOR
6	10'-0"	8'-0"	EXTERIOR INSULATED TRENCH GLASS DOOR
7	2'-0"	8'-0"	INTERIOR 2 PANEL DOOR
8	2'-4"	8'-0"	INTERIOR 2 PANEL DOOR
9	2'-0"	8'-0"	INTERIOR 2 PANEL DOOR
10	2'-4"	8'-0"	INTERIOR 2 PANEL DOOR
11	2'-4"	8'-0"	INTERIOR 2 PANEL DOOR
12	2'-4"	8'-0"	INTERIOR 2 PANEL DOOR
13	2'-0"	8'-0"	INTERIOR 2 PANEL DOOR
14	2'-4"	8'-0"	INTERIOR 2 PANEL DOOR
15	10'-0"	8'-0"	INTERIOR 2 PANEL DOOR
16	2'-0"	8'-0"	INTERIOR 2 PANEL DOOR
17	2'-0"	8'-0"	INTERIOR 2 PANEL DOOR
18	2'-4"	8'-0"	INTERIOR 2 PANEL DOOR
19	10'-0"	8'-0"	INTERIOR 2 PANEL DOOR
20	2'-4"	8'-0"	INTERIOR 2 PANEL DOOR
21	2'-4"	8'-0"	INTERIOR 2 PANEL DOOR
22	2'-0"	8'-0"	INSULATED INTERIOR 2 PANEL DOOR
23	2'-0"	8'-0"	INTERIOR 2 PANEL DOOR
24	2'-4"	8'-0"	INTERIOR 2 PANEL DOOR
25	2'-4"	8'-0"	INTERIOR 2 PANEL DOOR
26	10'-0"	8'-0"	EXTERIOR INSULATED TRENCH GLASS DOOR

WINDOW SCHEDULE					
SYMBOL	WIDTH	HEIGHT	GLASS LIGHT	DESCRIPTION	QTY
A	8'-0"	6'-0"	1/4"	INSULATED LOW-E SINGL. HUNG WINDOW	2
B	5'-0"	6'-0"	1/4"	INSULATED LOW-E SINGL. HUNG WINDOW	1
C	3'-0"	4'-0"	1/4"	INSULATED LOW-E SINGL. HUNG WINDOW	1
D	10'-0"	6'-0"	1/4"	INSULATED LOW-E SINGL. HUNG WINDOW	1
E	4'-0"	4'-0"	1"	INSULATED TRENCH CLEAR GLASS WINDOW	1
F	5'-0"	5'-4"	1/4"	INSULATED LOW-E SINGL. HUNG WINDOW	5

FIRST FLOOR NOTES

- ALL INTERIOR DOORS WILL BE 8'-0" TALL.
- DO NOT SCALE DRAWINGS. CONTRACTOR MUST VERIFY DIMENSIONS PRIOR TO START OF CONSTRUCTION (NOTIFY ARCHITECT IMMEDIATELY TO RESOLVE ANY DISCREPANCIES).
- INTERIOR DIMENSIONS ARE TO FACE OF STUD EXTERIOR DIMENSIONS ARE TO FACE OF BRICK OR OTHER FACE OF STUD WHERE EXTERIOR FINISH IS OTHER THAN BRICK OR STONE.
- DOUBLE JOIST UNDER ALL PARTITIONS PARALLEL TO FLOOR FRAMING (REGARDLESS OF LENGTH).
- PROVIDE 10'-0" CLG. HGT. UNLESS NOTED OTHERWISE.
- ALL STUD FRAMING ARE 2X4 @ 16" O.C. UNLESS NOTED OTHERWISE.
- ALL EXTERIOR DOORS TO HAVE WEATHERSTRIPPING, METAL THRESHOLD & DOOR SWEEP.
- PROVIDE SOLID SUPPORT UNDER EACH END OF BEAMS.

NEW SQUARE FOOTAGE	
OUTSIDE STUD (EACH TOWN HOME)	
SQUARE FOOTAGE (Cooled & cooled area only)	930 sqft
FIRST FLOOR	1080 sqft
SECOND FLOOR	404 sqft
THIRD FLOOR	404 sqft
TOTAL LIVING AREA	2420 sqft
SQUARE FOOTAGE (unheated area only)	
1 CAR GARAGE	320 sqft
COVERED PORCH	80 sqft
TOTAL UNDER ROOF	3820 sqft
ROOF DECK	256 sqft
REAR DECK	270 sqft

FIRST FLOOR PLAN
SCALE - 1/4" = 1' - 0"

REVISIONS

NO.	DATE	DESCRIPTION

"Notice": This set of drawings for a custom home is the copyrighted property of JKH DESIGN. This single copy is prepared pursuant to the terms and conditions of the design agreement and no right to reproduce or copy any portion of the plans.

These drawings are not to be reproduced by anyone or any method, including blueprinting, scanning, photocopying, tracing, re-drawing, or other means. They may not be used by anyone for repeat construction unless specifically, in writing, or any other purpose, without written consent of JKH DESIGN.

They may not knowingly be furnished to others for such purposes. They have been prepared by JKH DESIGN as an independent contractor and not as an employee of owner. All original tracing prepared by JKH DESIGN will remain in the office.

JKH DESIGN, 2013

JKH DESIGN ARCHITECTURAL
JURRI HALL
3919 Henricks Hill Drive
Smyrna, Tennessee 37167
Phone: 615-405-0310
jkhdesign@comcast.net / www.jkhdesign3.com

A NEW TOWNHOMES FOR:
MARGUERITA JACKSON
519 A & B WEAKLEY AVENUE
AND
521 A & B WEAKLEY AVENUE
NASHVILLE, TN 37207

Drawn	JKH
Checked	JLM
Flename	1.5
Issued	8-15-14

A-1.5

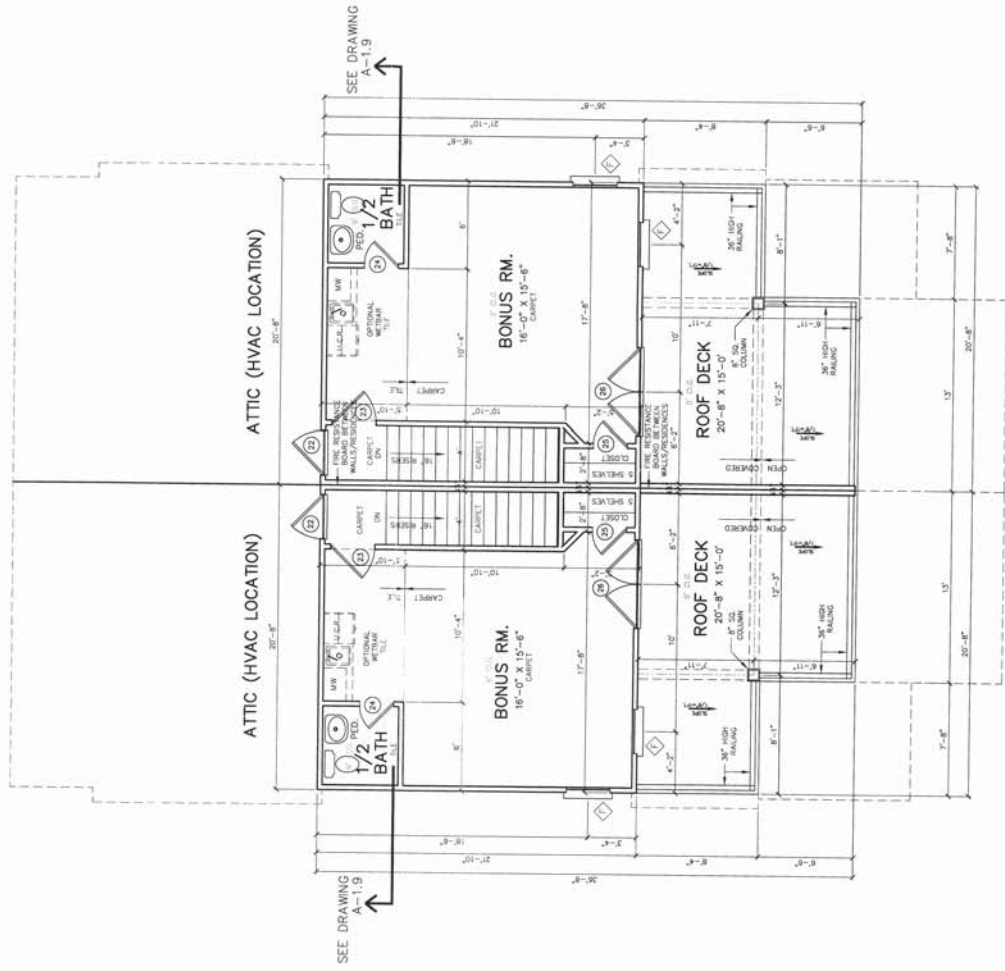

THIRD FLOOR NOTES

1. ALL INTERIOR DOORS WILL BE 6'-8" TALL.
2. DO NOT SCALE DRAWINGS. CONTRACTOR MUST VERIFY DIMENSIONS PRIOR TO START OF CONSTRUCTION. (NOTIFY ARCHITECT IMMEDIATELY TO RESOLVE ANY DISCREPANCIES).
3. INTERIOR DIMENSIONS ARE TO FACE OF STUD. EXTERIOR DIMENSIONS ARE TO FACE OF BRICK OR EXTERIOR FACE OF STUD WHERE EXTERIOR FINISH IS OTHER THAN BRICK OR STONE.
4. DOUBLE JOIST UNDER ALL PARTITIONS PARALLEL TO FLOOR FRAMING (REGARDLESS OF LENGTH).
5. PROVIDE 9'-0" C.G. HGT. UNLESS NOTED OTHERWISE.
6. ALL STUD FRAMING ARE 2X4 @ 16" O.C. UNLESS NOTED OTHERWISE.
7. ALL EXTERIOR DOORS TO HAVE WEATHERSTRIPPING, METAL THRESHOLD & DOOR SWEEP.
8. PROVIDE SOLID SUPPORT UNDER EACH END OF BEAMS.

THIRD FLOOR PLAN
SCALE - 1/4" = 1'- 0"

REVISIONS	

This set of drawings for a custom home is the intellectual property of JDH DESIGN, INC. No single copy is issued without the written consent of the owner. They may not be used by anyone for resale, reproduction, series brochures, advertising, or any other purpose without written consent of JDH DESIGN.

These drawings are not to be reproduced by anyone in any method, including duplicating, scanning, photographing, or otherwise. They may not be used by anyone for resale, reproduction, series brochures, advertising, or any other purpose without written consent of JDH DESIGN.

They may not knowingly be furnished to others for such purposes. They have been prepared by JDH DESIGN as an independent contractor and do not constitute an offer of contract. All original drawings prepared by JDH DESIGN will remain in the office of JDH DESIGN, 2013.

JDH DESIGN ARCHITECTURAL
J U R I H A L L
 3919 Henricks Hill Drive
 Smyrna, Tennessee 37167
 Phone: 615-405-0310
 johdesign@comcast.net / www.johdesign3.com

A NEW TOWNHOMES FOR:
MARGUERITA JACKSON
 521 A & B WEAKLEY AVENUE
 NASHVILLE, TN 37207

Drawn	JDH
Checked	JLM
Filename	1.7
Issued	8-15-14

A-1.7

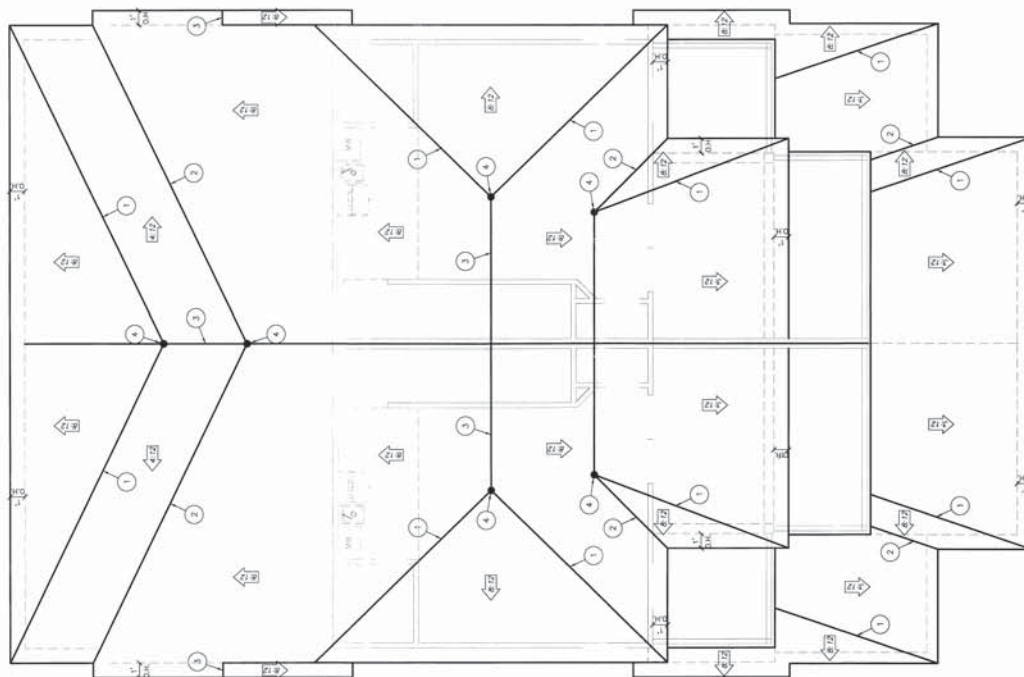

LEGEND:

- 1 HP
- 2 VALLEY
- 3 ROSE
- 4 2x6 PURLIN
- 5 OUTLOOKERS
- 6 CRICKET
- 7 KICKOUTS

ROOF PLAN
SCALE - 1/4" = 1'- 0"

NO.	DESCRIPTION	DATE

NOTICE: This set of drawings for a custom home is the copyrighted property of JDH DESIGN. This work may be issued pursuant to the terms and conditions of the design agreement and no right to reproduce or copy any portion of the plans.

These drawings are not to be reproduced by anyone or any method, including blueprinting, scanning, photocopying, tracing, re-drawing, or other means. They may not be used by anyone for repeat construction, resale, alteration, or any other purpose, without written consent of JDH DESIGN.

They may not knowingly be furnished to others for such purposes. They have been prepared by JDH DESIGN as an independent contractor and not as an employee of owner. All original tracings prepared by JDH DESIGN will remain in the office.

JDH DESIGN, 2013

JDH DESIGN ARCHITECTURAL

JULIE HALL
3919 Henrietta Hill Drive
Smyrna, Tennessee 37167
Phone: 615-405-0310
jdhdesign@comcast.net / www.jdhdesign-3.com

A NEW TOWNHOMES FOR:

MARGUERITA JACKSON
519 A & B WEAKLEY AVENUE
AND
521 A & B WEAKLEY AVENUE
NASHVILLE, TN 37207

Drawn	JDH
Checked	JLM
Filename	1.8
Issued	8-15-14

A-1.8

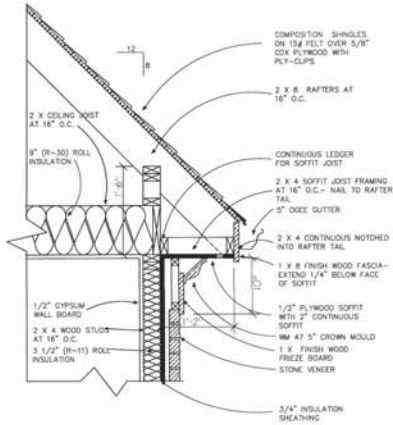

TYPICAL CORNICE SECTION (STONE VENEER)
SCALE: 1" = 1'-0"

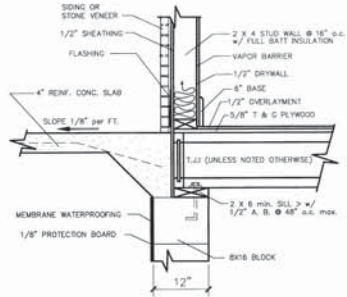

TYPICAL PORCH SLAB @ EXTERIOR WALL
SCALE: 1" = 1'-0"

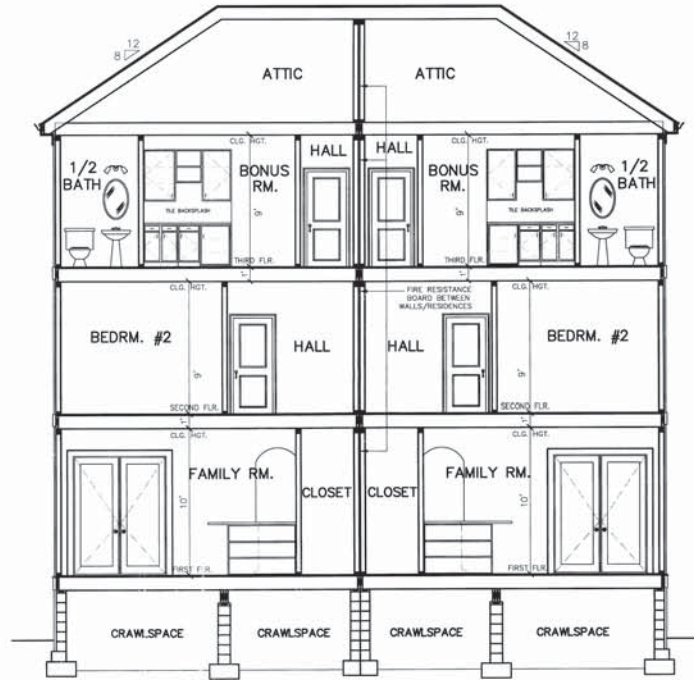

A-A SECTION
SCALE = 1/4" = 1'-0"

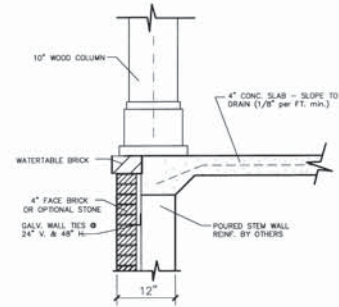

TYPICAL SECTION @ PORCH EDGE
SCALE: 1" = 1'-0"

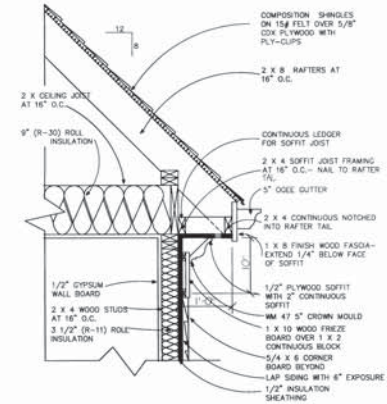

TYPICAL CORNICE SECTION (SIDING)
SCALE: 1" = 1'-0"

REVISIONS	

Notes: This set of drawings is a design concept and is the copyrighted property of JDH DESIGN. This single copy is loaned subject to the terms and conditions of the design agreement and no right to reproduce or copy any portion of the plans.

These drawings are not to be reproduced by any means or any method, including, but not limited to, photocopying, scanning, photographing, tracing, or otherwise, without the written consent of JDH DESIGN.

I hereby certify that I am a duly licensed professional engineer in the State of Tennessee, and that I have prepared these drawings as an independent contractor, and not as an employee of another. All original drawings prepared by JDH DESIGN shall remain in the office.

JDH DESIGN, 2010

JDH DESIGN ARCHITECTURAL
JURI HALL
3919 Henricks Hill Drive
Smyrna, Tennessee 37167
Phone: 615-405-0310
jdhdesign@comcast.net / www.jdhdesign3.com

A NEW TOWNHOMES FOR:
MARGUERITA JACKSON
519 A & B WEAKLEY AVENUE
AND
521 A & B WEAKLEY AVENUE
NASHVILLE, TN 37207

Drawn	JDH
Checked	JDH
Filename	1.9
Issued	8-15-14

A-1.9